

CEVAP ANAHTARI

1a.ABC Bağlamaca (9 Puan)

1 B E E E E B B B A
2 B C C G F E E G G

1b.ABC Bağlamaca (10 Puan)

1 A A A C G G G G E G
2 F F F F F F F I H E

2.ABC Kadar Kolay (13 Puan)

1 B A X D X X C X
2 A D B X C X X X

3.Amiral Battı (30 Puan)

1 1 X 4 4 2 2 X 2 X

4.Zigzag (16 Puan)

A D E G H F B C I

5.Hazine Avı (10 Puan)

4 1 2 7 1 1 6 2 2 2

6.Domino (24 Puan)

1 05
2 14

7.Apartmanlar (15 Puan)

1 6 3 4 2 1 5
2 4 6 5 1 3 2

8.Baş Harf (17 Puan)

1 LUBLİN
2 VARŞOVA

9a.İşlem Karesi (9 Puan)

1.Satır 8 5 2
2.Satır 7 9 6
3.Satır 4 1 3

9b.İşlem Karesi (14 Puan)

1.Satır 4 7 3
2.Satır 8 2 9
3.Satır 6 5 1

10.Çit (14 Puan)

1 1 0 0 0 1 0 1 0 1
2 1 0 0 0 1 1 1 1 1
3 1 1 1 1 1 0 0 1 0

11a.Köşe Kapmaca (9 Puan)

1	L	L	L	I	L	L	I	L	I	I
2	I	L	L	L	L	L	L	L	L	I

11b.Köşe Kapmaca (10 Puan)

1	I	L	L	I	L	L	L	L	L	L
2	L	I	I	L	L	L	L	I	L	I

12.Kakuro (19 Puan)

1	$\frac{12}{\diagdown}$	1	3	6	2	$\frac{13}{\diagdown}$	6	2	1	4
2	$\frac{14}{\diagdown}$	2	1	4	7	$\frac{19}{\diagdown}$	1	9	2	7

13.Adalar (11 Puan)

1	3,4
2	9

14.Tapa (20 Puan)

1	1	0	0	0	1	0	1	0	1	1	0	1
2	1	1	1	1	0	0	1	0	0	1	0	1
3	1	1	1	0	0	1	1	1	1	1	0	1

CEVAP ANAHTARI

1a.ABC Bağlamaca

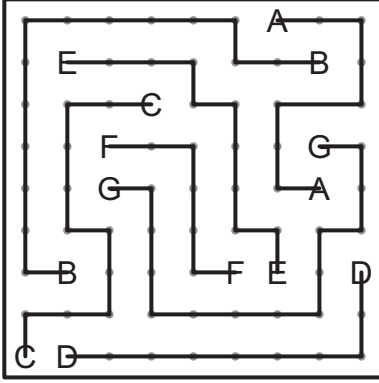

1b.ABC Bağlamaca

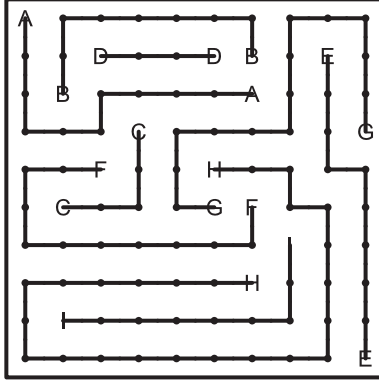

2.ABC Kadar Kolay

	B	C	D	B		B	
A				A	D	B	C
D				D	C	A	B
C		C		B		D	A
	B	A		D		C	
D			D	C	B	A	
	C	B	A				D
	A	D	B		C		
	D		C	A		B	
D	D		A	C		C	D

3.Amiral Battı

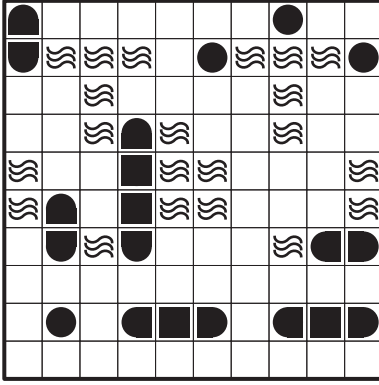

4.Zigzag

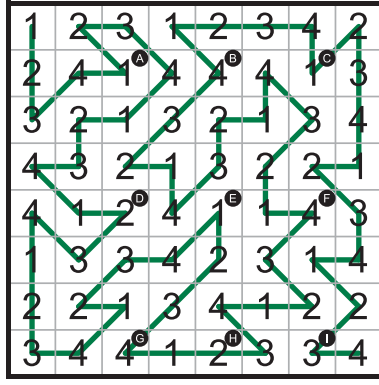

5.Hazine Avı

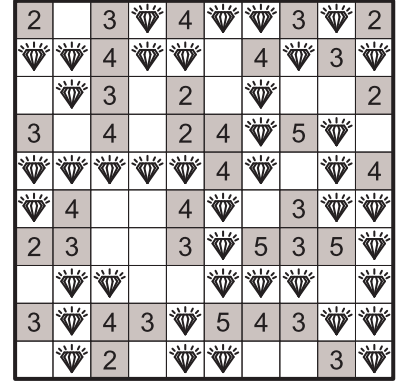

6.Domino

5	2	0	2	3	3	0	6
3	3	6	1	6	2	4	2
2	0	5	4	0	1	5	1
5	1	5	4	0	3	0	5
6	1	2	5	6	0	3	4
6	2	2	1	4	1	1	4
6	4	5	3	6	3	0	4

7.Apartmanlar

1-6		3	4		2	
	3	1	2	5	4	6
	6	3	4	2	1	5
	4	6	5	1	3	2
3	2	5	1	4	6	3
2	5	4	6	3	2	1
4	1	2	3	6	5	4
	4	2			3	

8.Baş Harf

										Ⓢ	
		Ⓒ	D	A	N	S	Ⓚ		Ⓛ	Ⓞ	Z
							R			P	C
							Ⓞ	A		O	Z
			Ⓩ		L		Ⓚ	İ	E	L	C
							İ	S		O	E
			Ⓡ	Z	E	S	Z	O	W		İ
					L	T			Ⓣ	O	R
					O	Y					
			Ⓟ	O	Z	N	A	N			
					A						

9a.İşlem Karesi

8	x	5	/	2	=	20
+		+		-		
7	+	9	+	6	=	22
-		+		/		
4	-	1	-	3	=	0
=		=		=		
11		15		0		

9b.İşlem Karesi

4	x	7	-	3	=	25
x		+		+		
8	+	2	x	9	=	26
-		-		/		
6	+	5	+	1	=	12
=		=		=		
26		4		12		

10.Çit

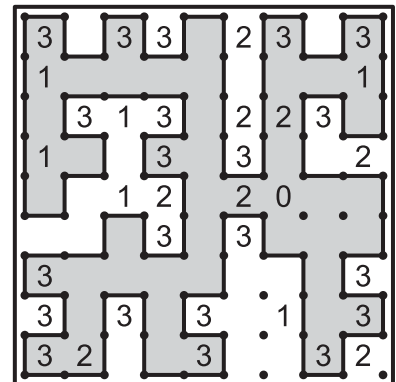

CEVAP ANAHTARI

11a.Köşe Kapmaca

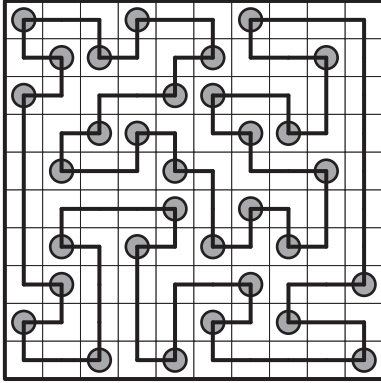

11b.Köşe Kapmaca

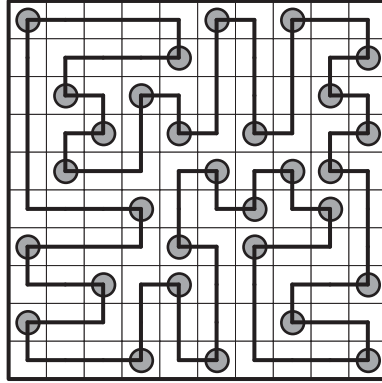

12.Kakuro

	10	26	4	7		4	16	20	22
21	4	9	3	5	14	1	7	4	2
14	3	8	1	2	27	3	9	8	7
8	2	6	27	3		9	20	7	9
12	1	3	6	2	13	6	2	1	4
	13	21	9	8	1	4	3	1	11
13	1	3	9	16		9	11	8	1
14	2	1	4	7	13	19	1	9	2
11	3	8	23	8	9	6	11	3	8
16	7	9	7	1	4	2	14	5	9

13.Adalar

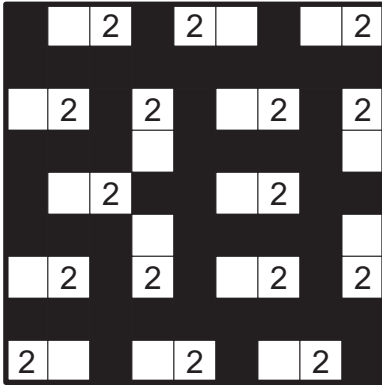

14.Tapa

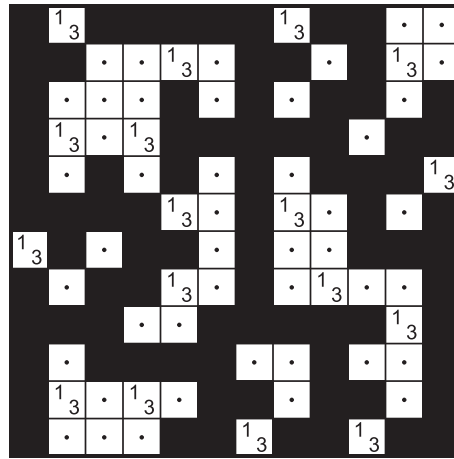

CEVAP ANAHTARI

1.Apartmanlar Kadar Kolay (16 Puan)

1	3	2	C	A	B
A	2	C	1	B	3

2.XO (15 Puan)

X	O	O	X	X	O	O	X	X	X
X	O	O	X	O	X	O	O	X	O
O	X	X	O	X	O	X	X	O	X

3.Savaş Yıldızları (25 Puan)

2	4	2	8	3	1	3	9	5	1	4
---	---	---	---	---	---	---	---	---	---	---

4.İşlemsiz Kendoku (30 Puan)

5	3	4	6	1	2
1	5	6	2	3	4
3	2	1	4	5	6

5.LITS (14 Puan)

I	S	S	A	T	T	T	A	A
A	A	A	L	A	S	A	L	A
I	A	L	A	I	I	I	I	A

6a.Masyu (10 Puan)

L	L	I	X	I	L	I	L	I	X
L	I	L	X	L	L	X	I	L	L
I	X	L	L	I	I	L	I	L	I

6b.Masyu (9 Puan)

I	I	I	I	L	L	I	L	I	L
I	I	L	I	L	I	L	I	L	I
I	L	L	X	L	I	L	I	I	I

7.Rakam Ağı (25 Puan)

7	4	1
5	3	6
2	9	8

8a.Sıkışmış Toplamlar (10 Puan)

X	3	1	X	2	4
4	X	2	X	1	3

8b.Sıkışmış Toplamlar (15 Puan)

4	X	2	3	1	X	5
X	1	3	4	5	2	X

9.Fillomino (10 Puan)

1	4	4	9	4	4	8	8	2	2
2	6	3	9	3	3	5	5	4	7
3	6	9	9	6	6	6	6	6	7

10.Harf Grupları (21 Puan)

1	A	R	Y	Ç	B
2	I	E	F	D	Ğ

11.Heykelli Park (27 Puan)

1	L	A	A	W	W	A	Z	Z	Z	A	U	U
2	A	P	P	A	F	F	A	A	X	A	A	A
3	A	A	T	T	T	A	V	A	A	A	A	I

12.Pentominous (16 Puan)

1	N	L	L	L	L	F	F	F	P	P
2	P	P	T	F	F	V	P	P	W	N
3	T	I	I	I	I	I	Z	U	U	U

13a.Mağara (9 Puan)

1	1,2
2	2,2,1

13b.Mağara (11 Puan)

1	5,1
2	3,3

14.Nanro (23 Puan)

1	3	X	1	X	4	4	5	5	5	2
2	2	X	X	X	2	X	1	X	X	X
3	3	X	3	3	1	X	3	X	3	X

15.Maksimum Patika (14 Puan)

1	L	L	L	L	L	I	L	I	L	L
2	I	I	L	L	I	L	L	I	L	L
3	L	L	L	L	L	L	L	I	L	I

CEVAP ANAHTARI

1.Apartmanlar Kadar Kolay

	B	C	2	3				
123 ABC	C	3	C	B	2	1	A	3
	C	1	3	2	C	A	B	B
		B	1	A	3	2	C	
		A	2	C	1	B	3	B
	B	2	B	3	A	C	1	C
	C	C	A	1	B	3	2	
	2		C	B	C			

2.XO

○	×	×	○	×	×	○	○	×	○
○	×	○	○	○	×	×	○	○	○
×	○	○	×	×	○	○	×	×	○
×	○	×	○	○	×	×	○	○	○
×	○	○	×	○	×	○	○	×	○
○	×	○	○	○	×	×	○	×	×
○	×	○	○	○	×	○	○	○	×
○	×	×	○	×	○	×	○	×	×
×	○	○	×	○	○	○	×	○	○
×	×	○	×	○	×	×	○	×	×

3.Savaş Yıldızı

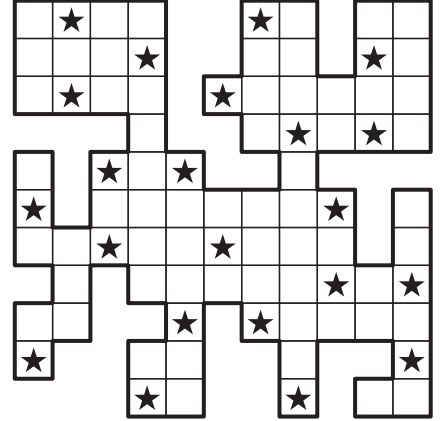

4.İşlemsiz Kendoku

5	3	4	6	1	2
4	6	5	3	2	1
1	5	6	2	3	4
2	4	3	1	6	5
3	2	1	4	5	6
6	1	2	5	4	3

5.LITS

I		S	S		T		
I	S	S			T	T	
I				S		L	L
I	L	L	L	S	S		L
			L		S		L
I	S	S		L	L	L	
I		S	S				L
I		L			I	I	I
I		L	L	L			

6a.Masyu

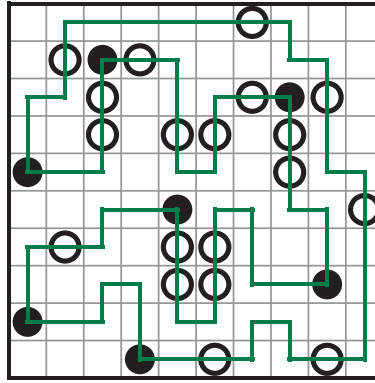

6b.Masyu

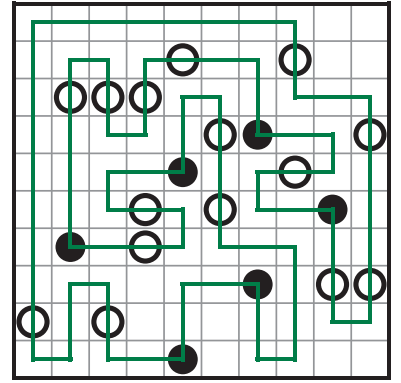

7.Rakam Ağı

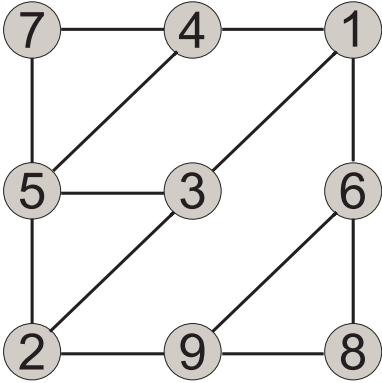

8a.Sıkışmış Toplamlar

	9	6		6	9	
3		4	2		1	
7	1	2		3	4	
		3	1		2	4
8		4	3	1		2
	4		2		1	3
7	2	1		4	3	

8b.Sıkışmış Toplamlar

	6	1	10	2		5	7
1	2	4		1		5	3
	4		2	3	1		5
15		1	3	4	5	2	
5	1		5		2	3	4
6	5	3		2	4		1
6		5	1		3	4	2
1	3	2	4	5		1	

9.Fillomino

5	5	5	5	7	7	7	7	7
4	5	4	4	7	2	2	1	7
4	4	9	4	4	8	8	2	2
4	9	9	8	8	8	8	7	7
6	6	9	2	2	1	8	4	7
6	3	9	3	5	5	8	4	7
6	3	9	3	3	5	5	4	7
6	3	9	6	2	2	5	4	7
6	9	9	6	6	6	6	6	7

10.Harf Grupları

1	2	3	4	5
P	A	Z	I	L
M	R	T	E	N
U	Y	S	F	K
Ş	Ç	O	D	H
J	B	Ü	Ğ	İ

11.Heykelli Park

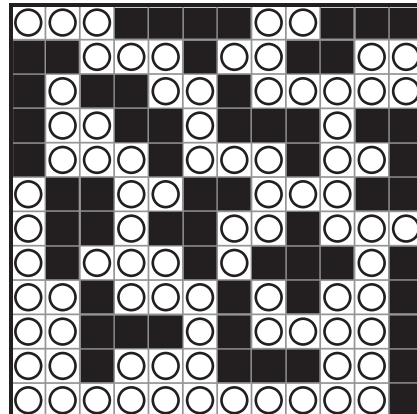

12.Pentominous

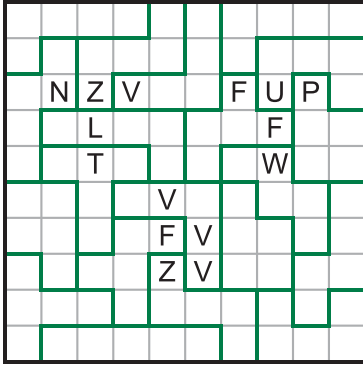

13a.Mağara

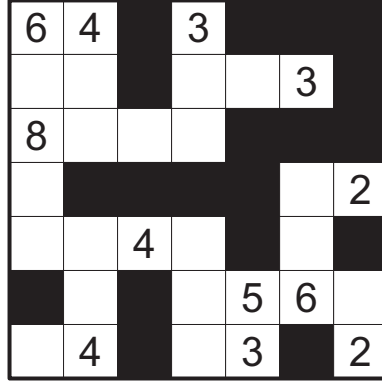

13b.Mağara

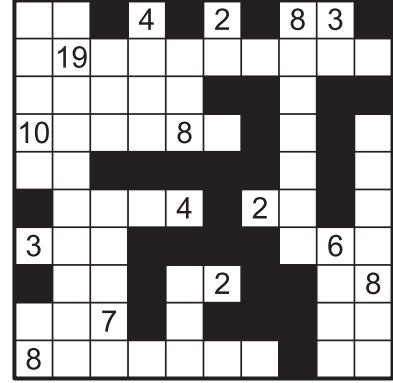

14.Nanro

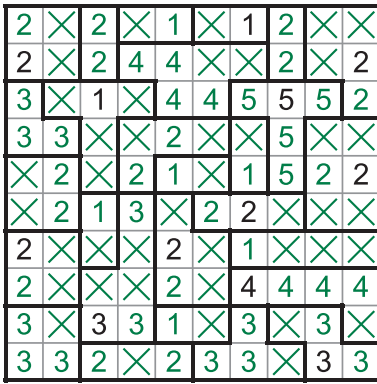

15.Maksimum Patika

